

ITEM NO.:A101012600

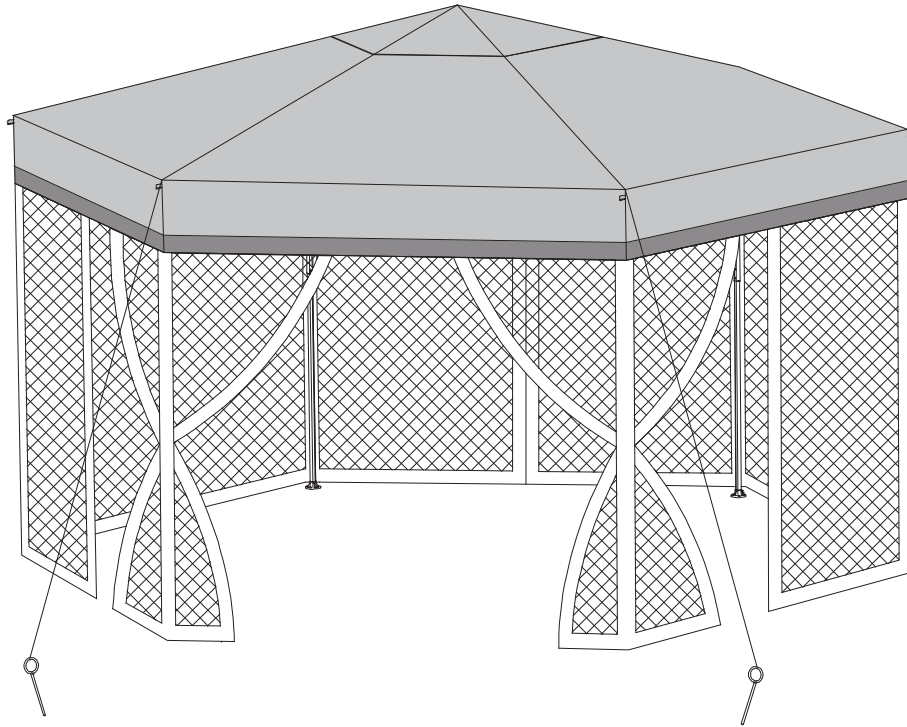

WE HAVE YOU IN MIND, LET US SERVE YOU!

Questions? Issues?

CONTACT US

24 hours / 7 days a week

 **Warranty Parts**

www.sunjoyonline.com



customer.care@sunjoygroup.com



A10101260022

Country of Origin: China

Production Number: xxxxxxxxxx

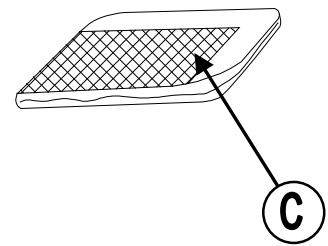
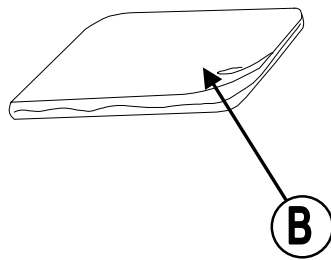
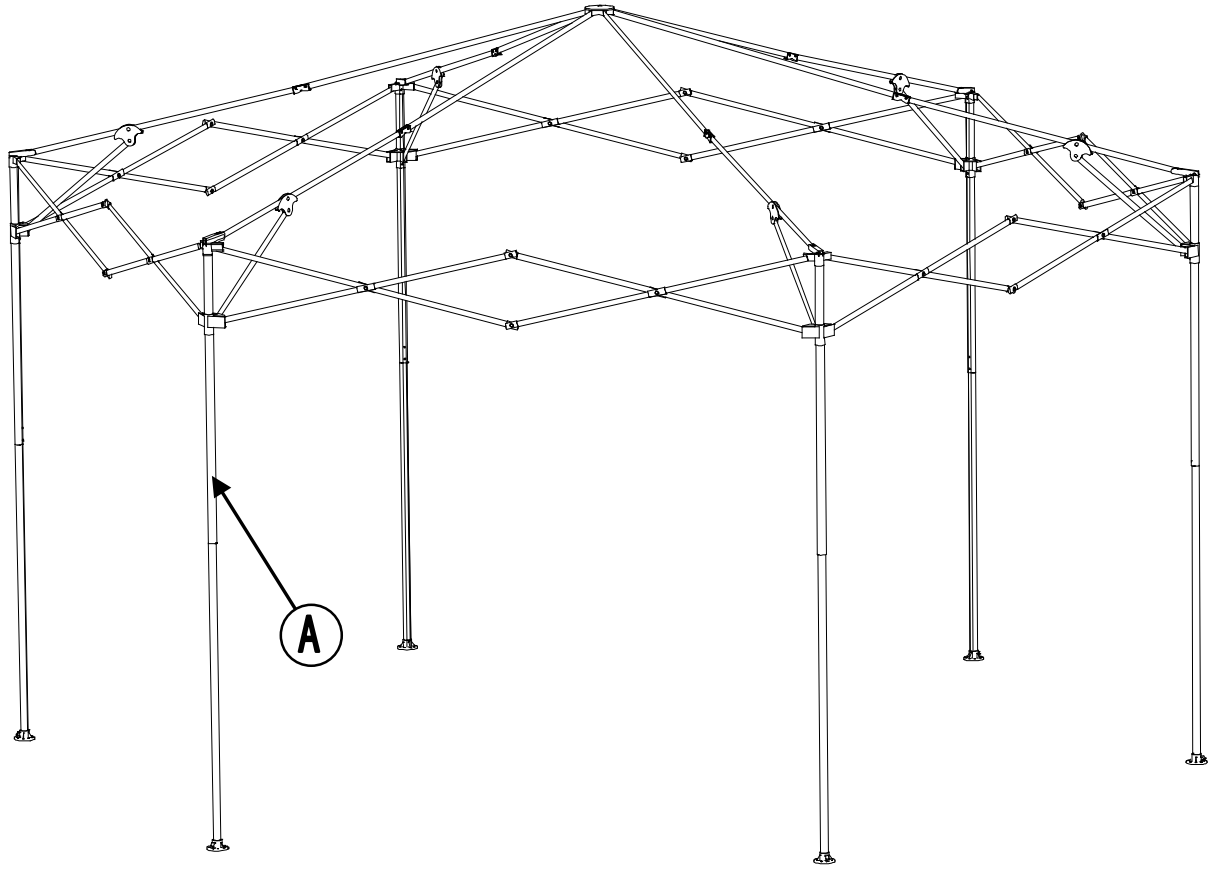

Country of Origin: China



Warning! To reduce the risk of serious injury, read the following safety instructions before assembling and using the gazebo.

Caution! Always keep children under close supervision while they are using or around this product. Never leave children unattended.

- Assembly instructions must be followed.
- Pegs supplied must be used to hold this gazebo in place when upright.
- Do not use candles, matches or open flames of any kind in or near the gazebo.
- Do not cook inside gazebo.
- Build campfires downwind and several meters away from the gazebo, and be sure to fully extinguish campfires before leaving a campsite or before retiring for the night.
- Exercise extreme caution when using fuel-powered lanterns or heaters inside the gazebo, and use battery-operated lanterns whenever possible.
- Do not refuel lamps, heaters or stoves inside the gazebo.
- Extinguish or turn off all lanterns before going to sleep.
- Do not smoke in the gazebo.
- Do not store flammable liquids inside the gazebo.
- **KEEP ALL FLAME AND HEAT SOURCES AWAY FROM THIS GAZEBO FABRIC.**
This gazebo is made of flame-resistant fabric. It is not fireproof. The fabric will burn if left in continuous contact with a flame source.

USE AND CARE:

- This gazebo is not a permanent structure and should be disassembled and stored away after use.
- Do not repack your gazebo until completely dry.
- In order to reduce the risk of personal injury and damage to equipment, basic safety precautions should always be followed when assembling and using this product. Read all instructions carefully before assembly and use.
- Some parts may contain sharp edges. Wear protective gloves if necessary. In order to ensure safe assembly, it is recommended that this product be assembled by at least two people.
- Keep children and pets away from the assembly area.
- Begin assembly at least 6' (1.8 m) away from any obstruction, such as a fence, garage, house, overhanging branches, laundry line, or electrical wires.
- Install gazebo on level ground. Anchor the gazebo to the ground with stakes for added safety. Stakes are provided to secure the gazebo to the ground. If you wish to secure the gazebo to concrete and wood surfaces, use anchors suited for these surfaces (anchors not included). Gazebo is intended for decorative and sunshade purposes only, and is not designed to withstand harsh weather, including high winds, rain, and snow.
- Verify that all nuts and bolts are tightly secured before and during use.
- Remove canopy or take other precautions in high wind conditions.
- Anchor or stake a minimum of four (4) locations of the unit to the ground for added safety and security.

IMPORTANT: RETAIN FOR FUTURE REFERENCE AND READ CAREFULLY.

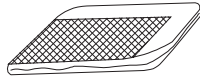
A P005900009Gazebo Frame - **1****B** P001100566Canopy - **1****C** P001200219Mosquito Netting - **1****AA** H070010018Stake $\Phi 3 * 145$ - **12****BB** H070010021Stake $\Phi 4 * 180$ - **6****CC** P008300002Rope - **6****DD** P00760010900Bag - **1**

**Caution!**

- Proper placement of your gazebo is essential.
Do not place the product underneath electrical lines.
- Keep children away during assembly.
This product contains small parts which can be swallowed by children.
- Keep fingers away from the places where they can be pinched or trapped.
- Do not attempt to assemble the gazebo if any parts are missing.

Place all parts from the box in a cleared area and position them on the floor in front of you. Remove all packing materials and place them back into the box. Do not dispose of the packing materials until assembly is complete. Read each step carefully before beginning any assembly and make sure you understand each step. If you are missing a part, please call our toll-free number for assistance.

Needed for assembly: (The following tools are not included)

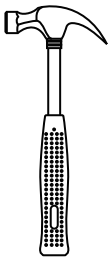

Hammer



Screwdriver

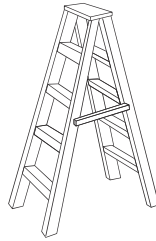

Ladder



2 people

Country of Origin: China

1

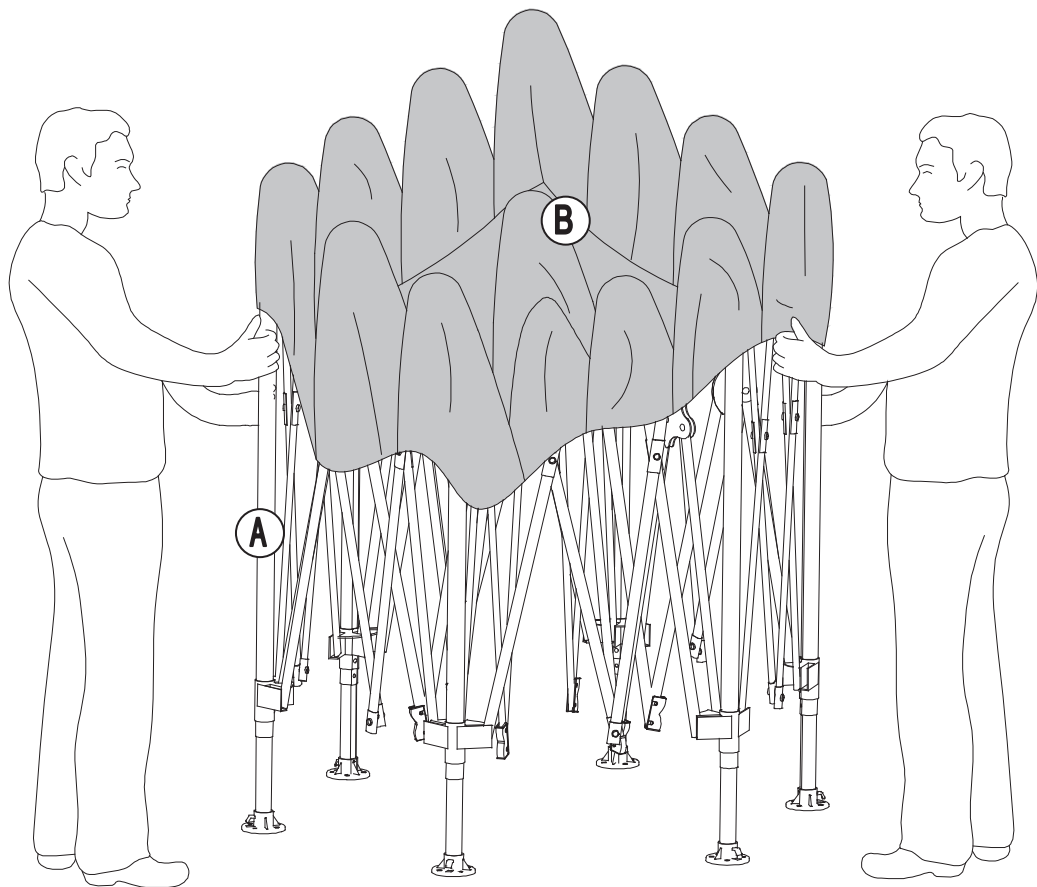
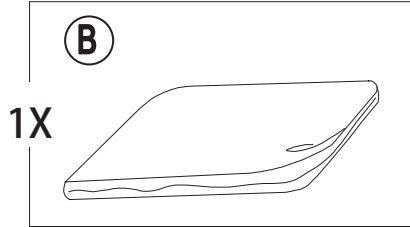
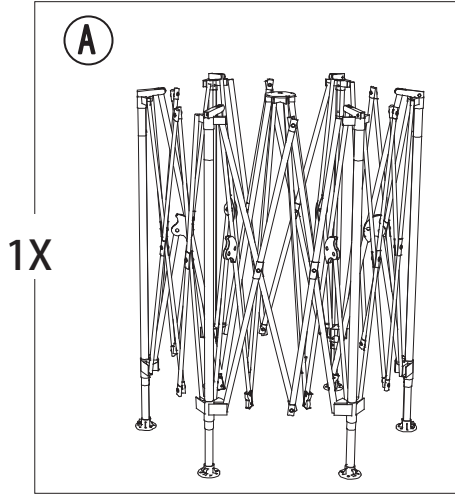

2

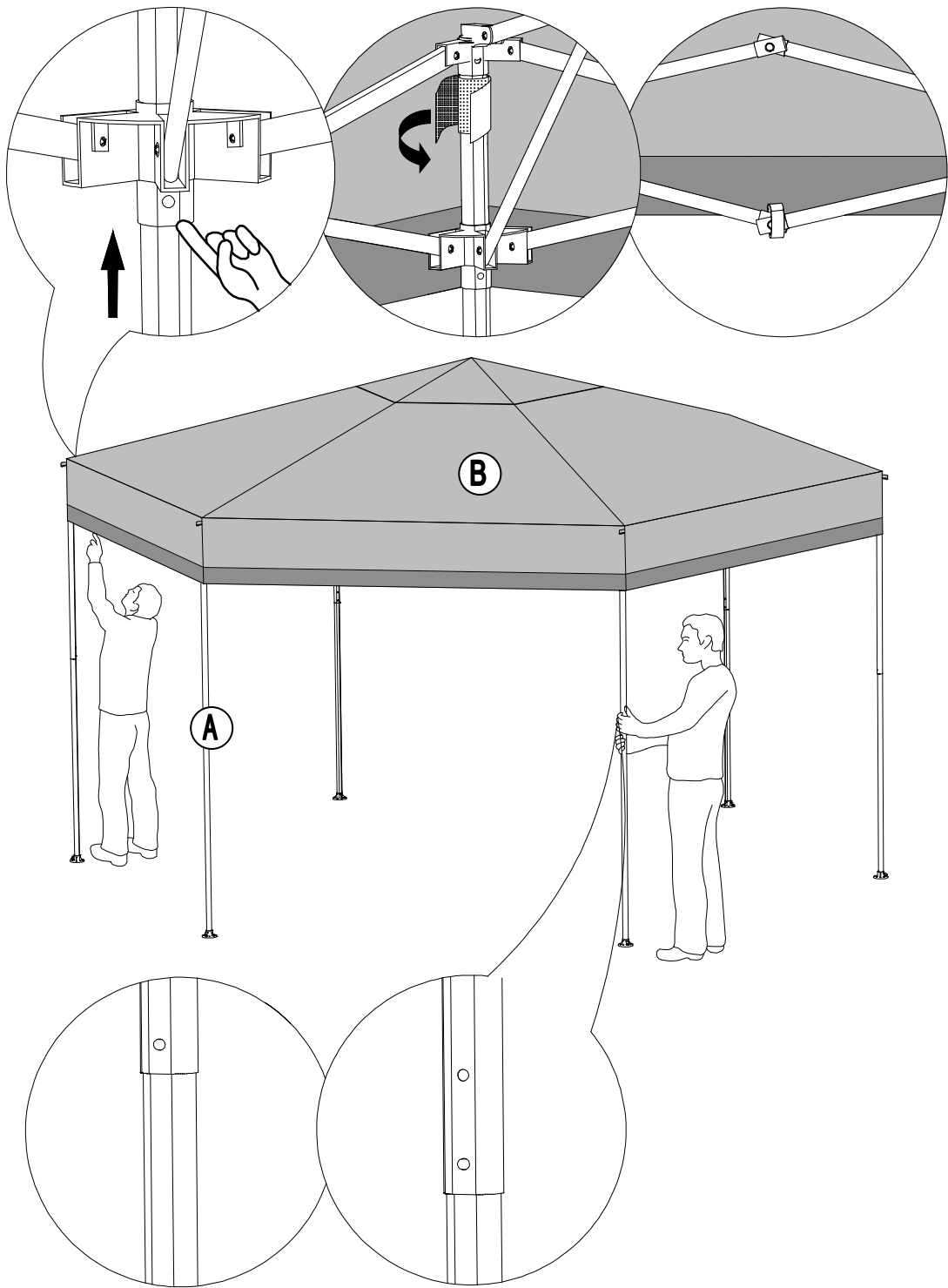

Country of Origin: China

3

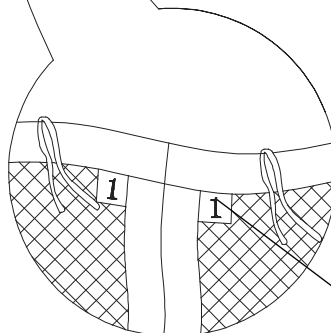
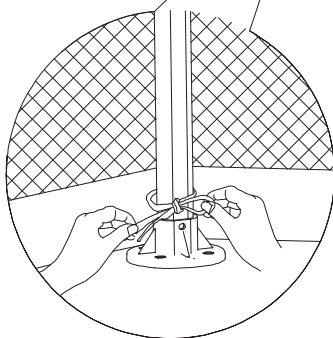
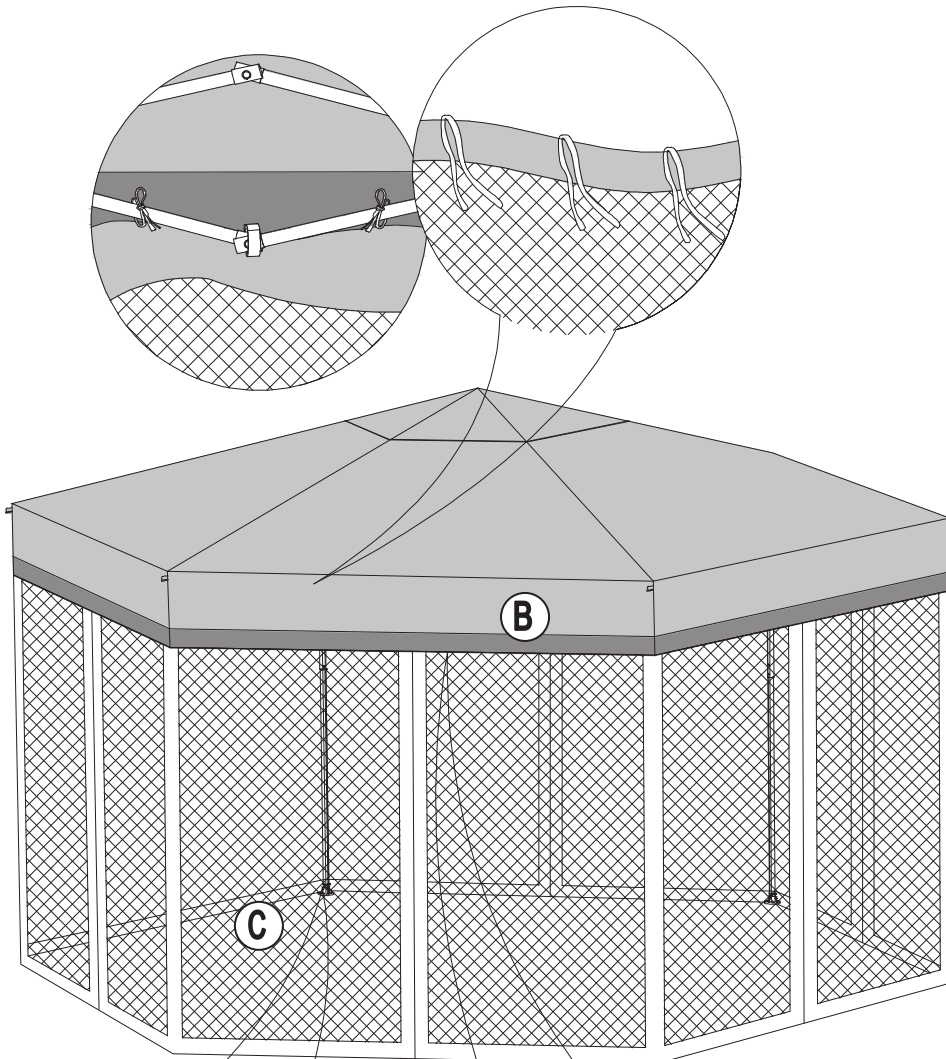
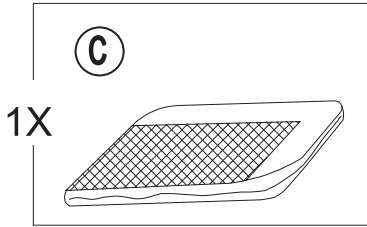

Match the panel zippers by number as shown in the illustration.

4

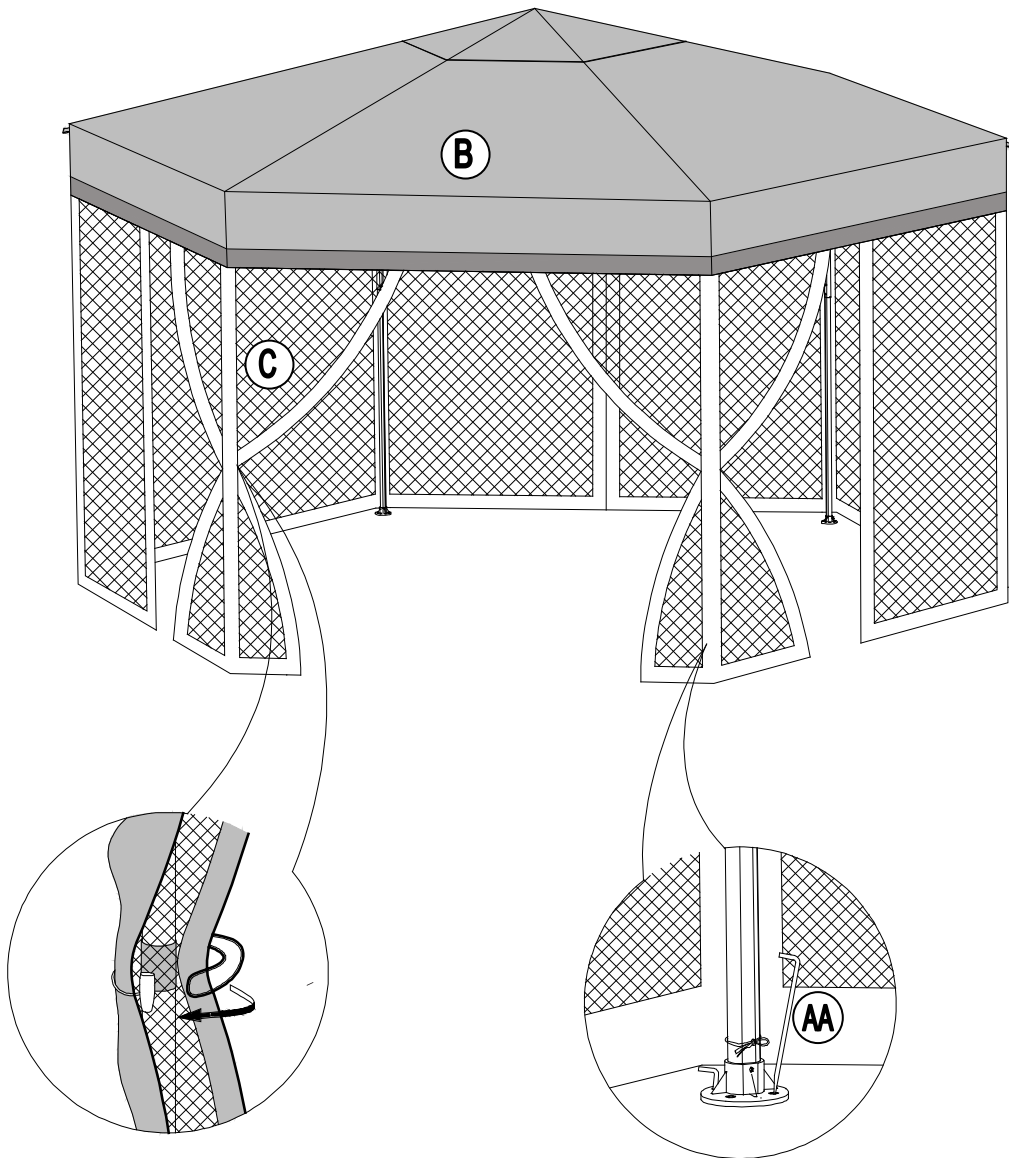
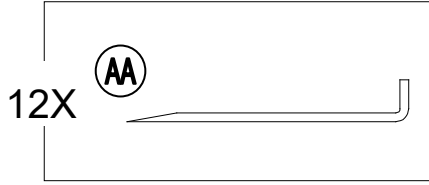

Country of Origin: China

5

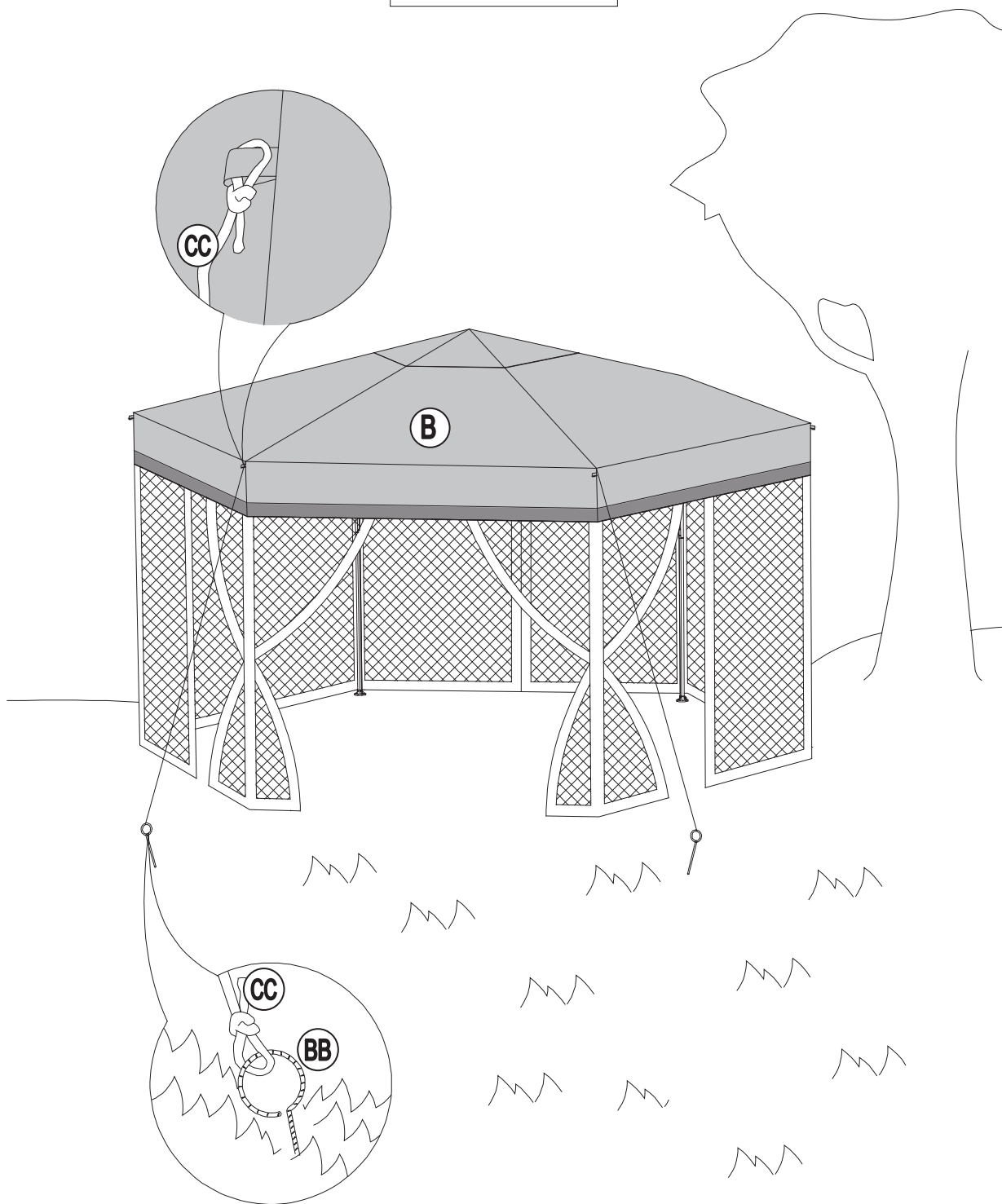
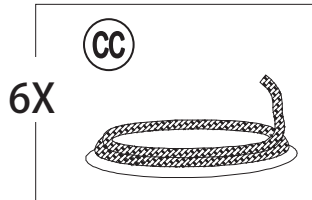
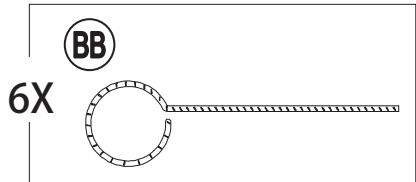

Care and Maintenance

- Our steel components for garden accessories and furniture are treated with rust inhibiting paint that protects it from rusting. However, due to the nature of steel, surface oxidation (rusting) will occur once these protective coatings are scratched. This is not a defect and thus not covered by the warranty.
- To minimize this condition, we recommend care when assembling & handling the product to prevent scratching the paint. Should any scratching or damage occur, we recommend immediate touch-up with rust inhibiting paint.
- Surface rust can also be easily removed with a very light application of common cooking oil. If surface oxidation (rusting) occurs and if no measure is taken to prevent this, the oxidation may start dripping on to deck or patio and caused damaging stains, which may be difficult to remove. This can be prevented if the above-mentioned measures are taken to keep the product from oxidizing.
- Use damp cloth to wipe off the stains as quickly as possible.
- If necessary, wash with a mild solution of soap and water; rinse thoroughly and dry completely.
- Periodically check and ensure that all bolts are well-tighten during use

Limited Manufacturer's Warranty

Sunjoy Group warrants to the original purchaser that this item is free from defects in workmanship and materials for a period of 12 months from the date of purchase, provided the item was factory-sealed at the time of purchase and is maintained with care and used only for personal, residential purposes. Should any manufacturing defect arise within this warranty period, Sunjoy Group will replace (at our option) any defective merchandise or parts upon proof of purchase; however, transportation and delivery costs, as well as payments to a third party for assembly or disassembly of the item, remain the responsibility of the purchaser. A purchaser of an "open box," previously-returned, or "clearance" item, as well as original purchasers outside of the warranty period, may obtain replacement parts from Sunjoy Group for products in current production, at nominal cost.

Exclusions:

Items used for commercial, contract, or other non-residential purposes, or items damaged due to acts of nature, vandalism, misuse, or improper assembly are not covered. Corrosion or rusting of hardware is not covered. Proof of purchase (dated register receipt) is required for warranty claims. Warranty is to the original purchaser and is non-transferable. Any replacement of warranted items will be in the original style and color, or a similar style and color if the original is unavailable or has been discontinued. As some states do not allow exclusions or limitations on an implied warranty, the above exclusions and limitations may not apply. This warranty gives you specific rights, and you may also have other rights, which vary from state to state.

Country of Origin: China